

\*\*\* NON MONTARE SUL PCB

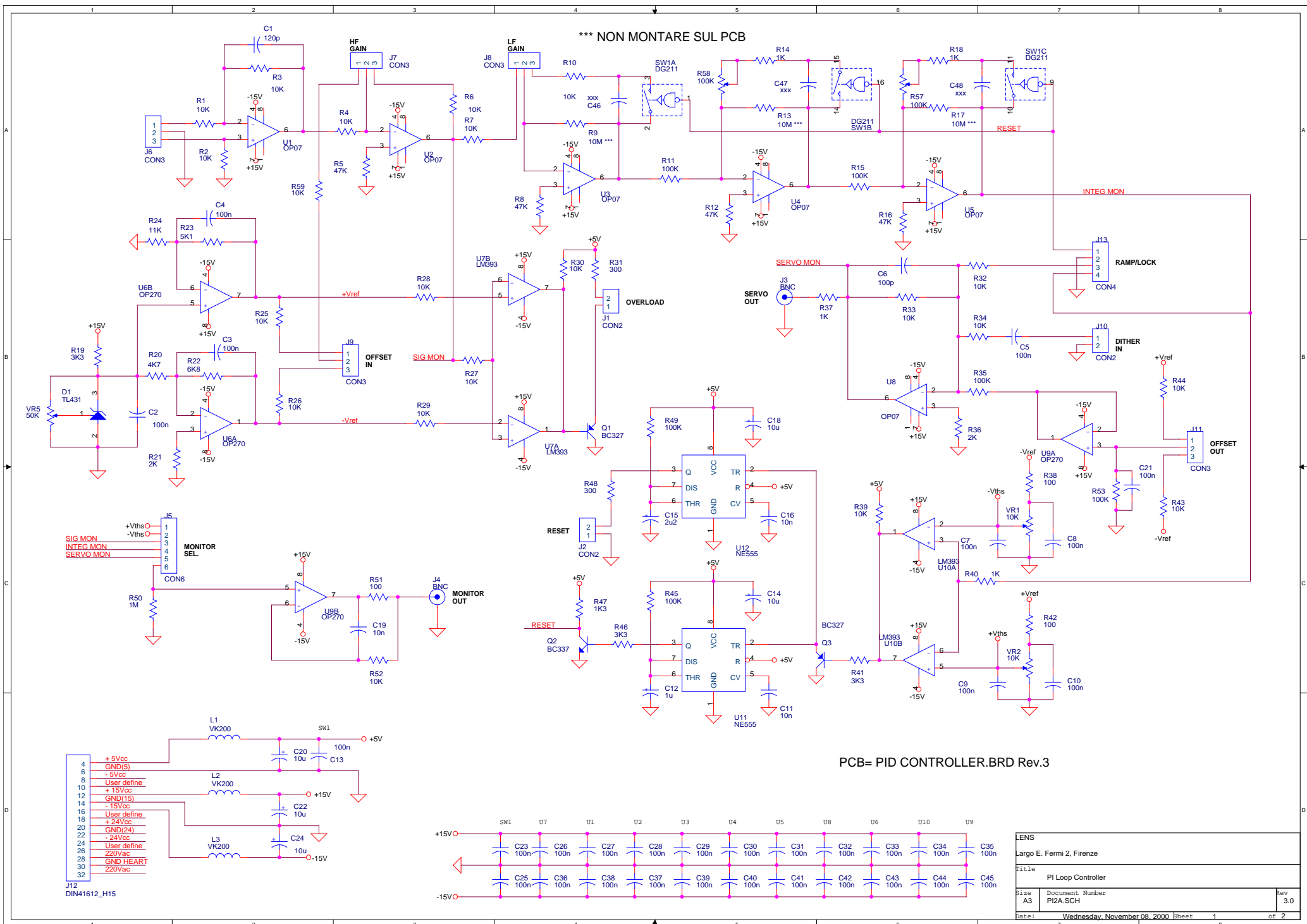

PCB= PID CONTROLLER.BRD Rev.3

LENS	
Largo E. Fermi 2, Firenze	
File: PI Loop Controller	
Size: A3	Document Number: PIZA.SCH
Date: Wednesday, November 08, 2000	Sheet: 1 of 2
Rev: 3.0	

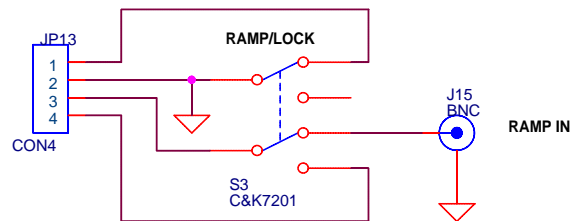
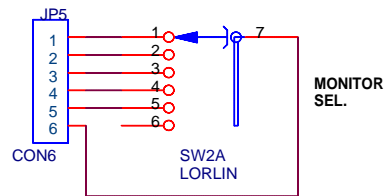
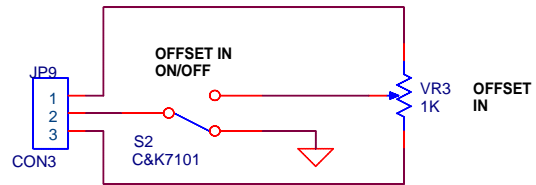
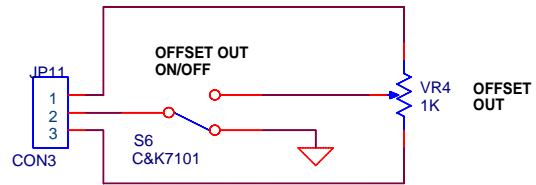
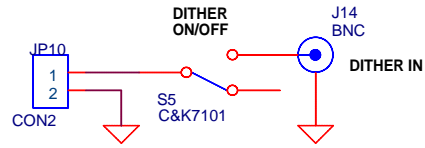
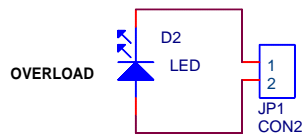
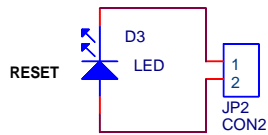
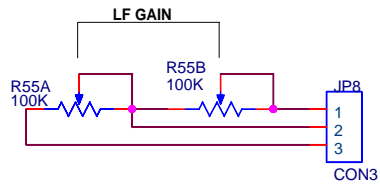
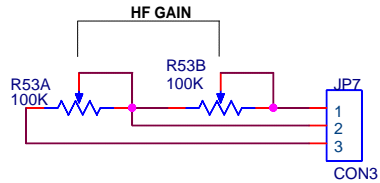
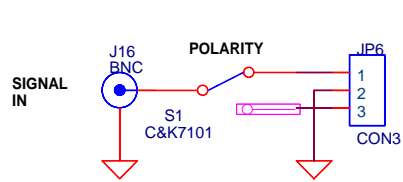

Title		
PI Loop Controller		
Size	Document Number	Rev
A4	PI2B.SCH	3.0
Date:	Monday, May 03, 2004	Sheet 2 of 2